

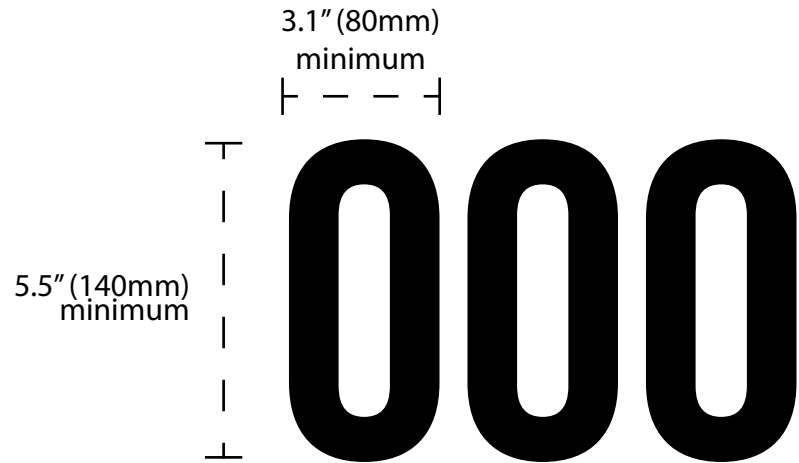

2019 SEASON
NUMBER AND MOTORCYCLE LOGO
GUIDELINE. COMPETITOR BULLETIN 02-2019

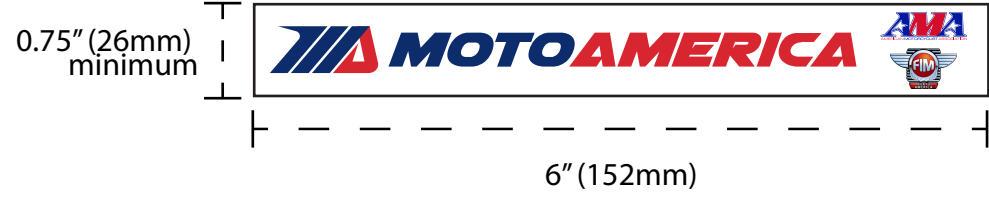

* minimum stroke is 0.75" (20mm)
** minimum space between numbers is 0.40" (10mm)

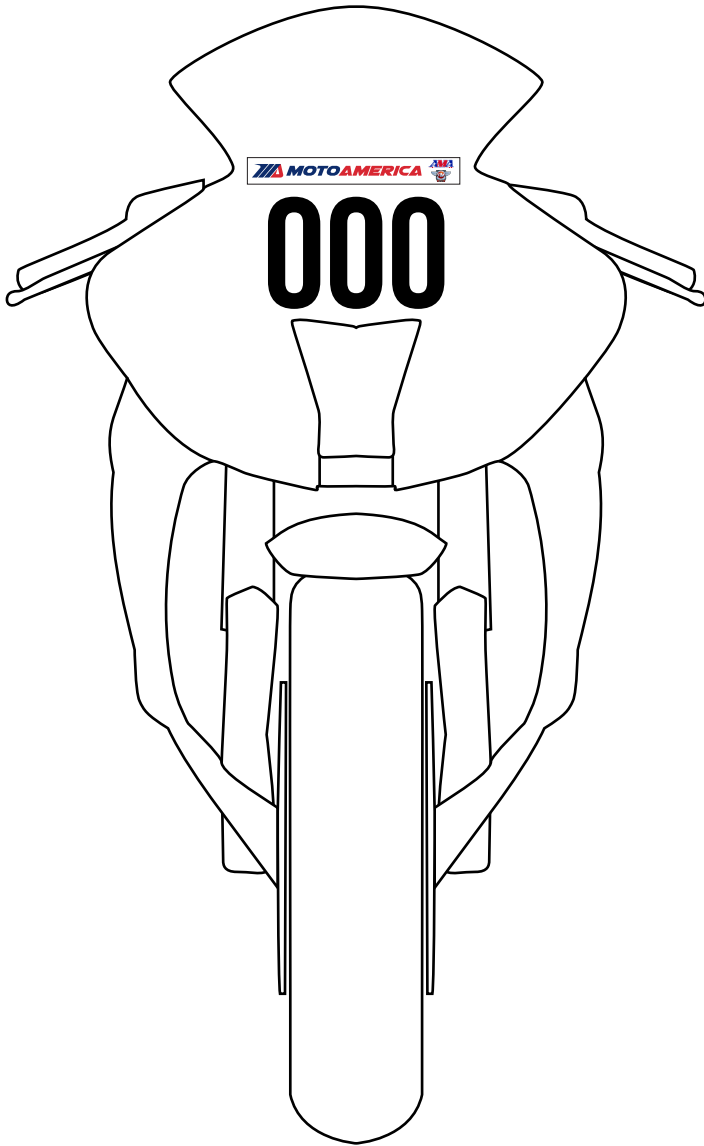
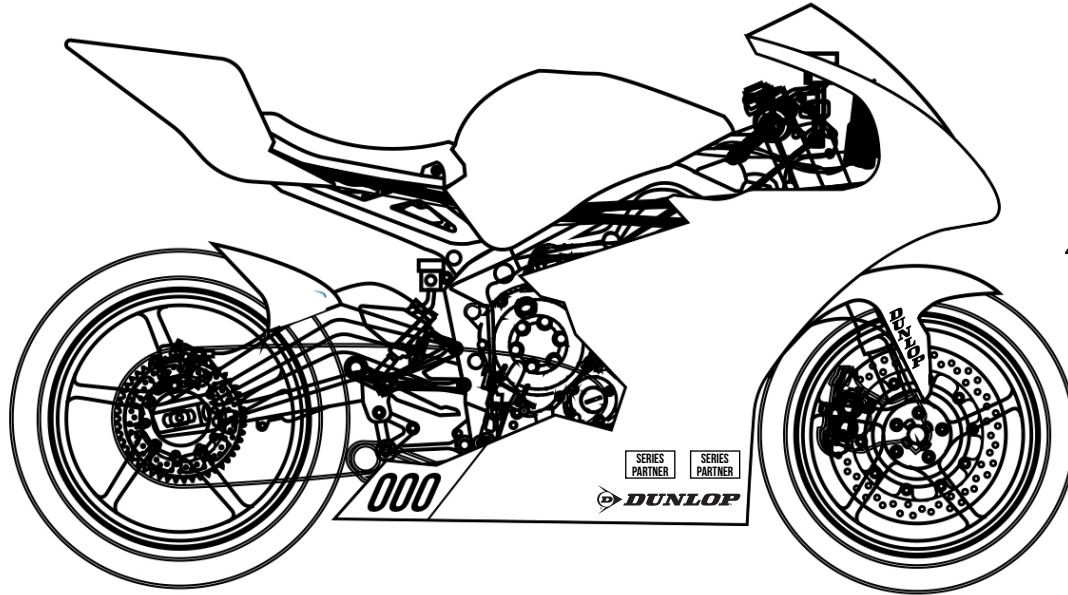

2.75" (70mm)
minimum

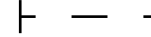

4.75" (120mm)
minimum

000

* minimum stroke is 0.75" (20mm)
** minimum space between numbers is 0.40" (10mm)

2.5" (63mm)
minimum

**SERIES
PARTNER***

3" (76mm)

2.5" (63mm)
minimum

**SERIES
PARTNER***

4" (101mm)

2.5" (63mm)
minimum

DUNLOP

12" (305mm)

5.5" (140mm)
minimum

**D
U
N
L
O
P**

1.67" (42mm)